



Planetary Mixers Planetary Mixer, 8 Lt. - Electronic

ITEM # _____

MODEL # _____

NAME # _____

SIS # _____

AIA # _____



600139 (DBE8BY)

8 Lt planetary mixer, bowl detection device, electronic speed variation. Equipped with stainless steel spiral hook, paddle and whisk. Equipped with highly resistant safety screen - BPA free

Short Form Specification

Item No. _____

Suitable for all kneading, blending and whipping operations. Aluminium body and metal base for complete stability. 8 litre capacity 18/10 (AISI 304) stainless steel bowl. Powerful asynchronous motor with electronic speed variation from 20 to 220 rpm (planetary movement). Removable/transparent solid safety screen - made of a bisphenol-A free (BPA) copolyester - activates the raising and lowering of the bowl. Bowl detection device allows the mixer to switch on only when the bowl and the safety screen are properly installed and positioned together. Supplied with 3 stainless steel dw safe tools: spiral hook, paddle and whisk.

Main Features

- Professional compact table top beater mixer for intensive kneading, mixing and whipping.
- Maximum capacity 2.5 kg flour, with 60% of hydration.
- Delivered with: Spiral Hook, Paddle, Wire Whisk and Mixing Bowl for 8 lt. All made in stainless steel and dishwasher safe.
- Tools shape and size perfectly adapt to the bowl for uniform mixing of even small quantities.
- Electronic speed variator.
- Ergonomic and reliable knob to select the speed adjusting to the tool and mixture hardness.
- Removable safety screen activates the raising and lowering of the bowl.
- Bowl detection device allows the mixer to switch on only when the bowl and the solid safety screen are properly installed and positioned together.

Construction

- 304 AISI stainless steel 2 handles bowl - 8 lt. capacity.
- Compact and portable design.
- Asynchronous motor with high start-up torque.
- Variable speed from 20 to 220 rpm (planetary movement), to adjust to the selected tool and mixture hardness.
- Planetary movement based on self lubricating gears, eliminating any risk of leaks.
- Water protected planetary system (IP55 electrical controls, IP34 overall machine).
- Transparent solid safety screen made of Eastman Tritan™ copolyester BPA free, impact resistant and stays clear and durable after several dishwashing cycle. Eastman&Tritan are trademarks for Eastman Chemical Company.
- Variable speed rotation of the tools from 67 rpm to 740 rpm.

Included Accessories

- 1 of Stainless steel bowl 8 Lt PNC 653766
- 1 of Stainless steel spiral hook 8 Lt PNC 653767
- 1 of Stainless steel paddle 8 Lt PNC 653768
- 1 of Stainless steel whisk 8 Lt PNC 653769

Optional Accessories

- Stainless steel bowl 8 Lt PNC 653766 □

APPROVAL: _____



Planetary Mixers Planetary Mixer, 8 lt. - Electronic

- Stainless steel spiral hook 8 lt PNC 653767
- Stainless steel paddle 8 lt PNC 653768
- Stainless steel whisk 8 lt PNC 653769
- Closed splash guard for BE5/8 without accessory hub PNC 653781



Planetary Mixers
Planetary Mixer, 8 lt. - Electronic
The company reserves the right to make modifications to the products
without prior notice. All information correct at time of printing.

2024.04.03

Front

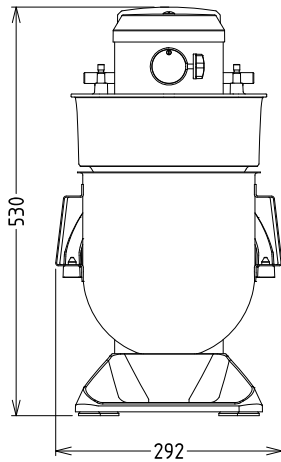

Electric

Supply voltage:

600139 (DBE8BY) 200-240 V/1N ph/50/60 Hz

Capacity:

Performance (up to): 2.5 kg/Cycle

Capacity: 8 litres

Key Information:

External dimensions, Width:

292 mm

External dimensions, Depth:

416 mm

External dimensions, Height:

527 mm

Shipping weight:

ISO 9001; ISO 14001 kg

Net weight (kg):

19

Cold water paste:

2.5 kg with Spiral hook

Egg whites:

14 with Whisk

Side

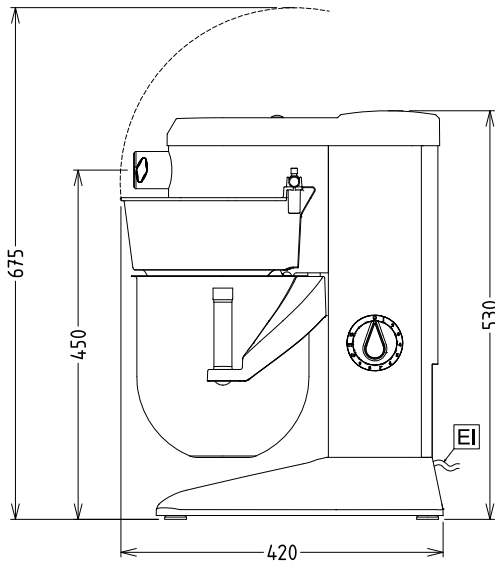

EI = Electrical inlet (power)

Top

